

SPLIT TYPE

AIR TO WATER HEAT PUMP

Heating & Hot Water

Heating & Cooling & Hot Water

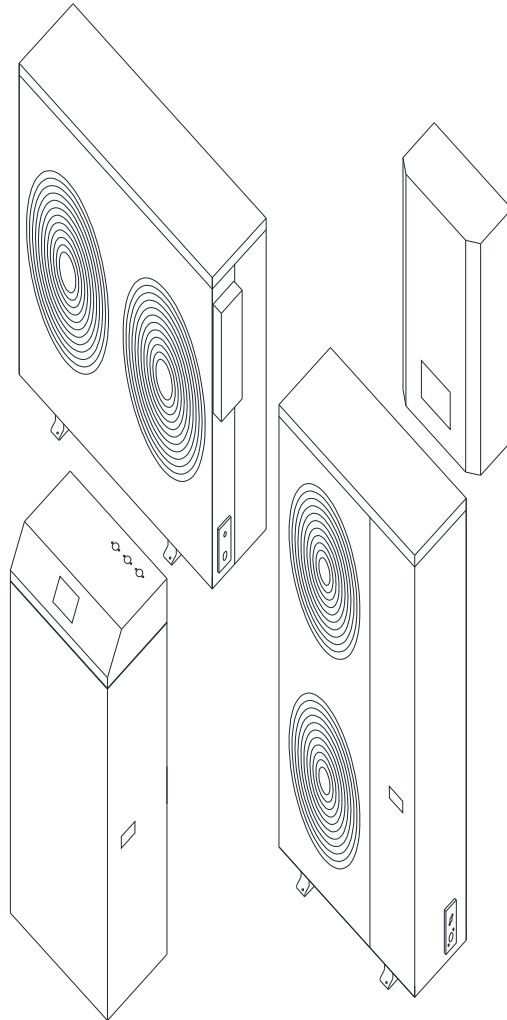

Installation, Operation and Maintenance Manual

Local laws and regulations must be followed during installation.

Table of Contents

Before Installation.....3
Installation Position.....5
Installation Layout.....6
Antifreeze Protection.....7
System Connection.....8
System Introduction.....10
Pipeline Connection.....16
Electrical Connection.....22
Control.....29
Warnings.....46
Test Run and Debugging.....52
Preservation and Maintenance.....53

Before Installation

Handling and Storage

During handling of the unit, the angle of inclination shall not exceed 30° (Figure A). It shall be vertically placed in a dry and ventilated place during storage.

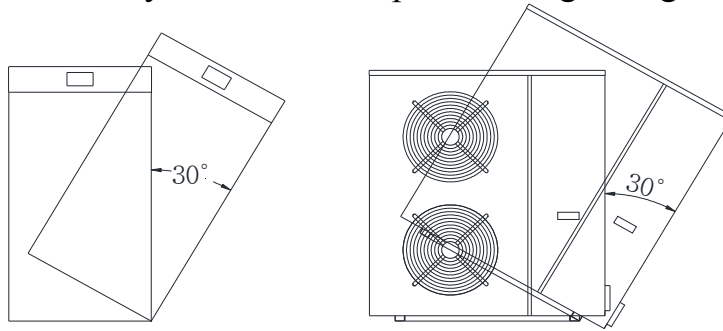

Figure A

The unit must be installed according to local laws and regulations.

Safety

Only qualified personnel are allowed to install the unit in order to avoid possible damage of equipment or personal injury due to incorrect installation.

In case of any failure or leakage, the operation of the unit shall be stopped immediately and the power supply shall be cut off before repair; if the unit is repaired, the safety devices and parameters of the unit must be rechecked.

In case of leakage of refrigerant, recycling device shall be used to recycle the residual refrigerant in the recycling system to a portable refrigerant steel cylinder.

Attentions: The refrigerant will generate hazardous substances after high-temperature decomposition.

Attentions: Make sure the type of refrigerant filled is same as required in the nameplate.

The filling of refrigerant of wrong type will result in irreparable damage to the compressor.

Violent chemical reactions with oil and grease, only refrigerant or dry nitrogen can be used for testing and cleaning.

Do not surpass the maximum working pressure stipulated.

Before Installation

Do not cut or use flame cutting equipment to cut refrigerant pipeline and circuit until the refrigerant (liquid and gas) is fully exhausted from the system and the traces are cleaned by dry nitrogen.

Hazardous gas will be generated if the refrigerant contacts with open flame.

Make sure necessary safety protection equipment is adopted during installation and repair. Proper fire extinguishers shall be used.

Do not touch the refrigerant.

Proper protection measures shall be adopted to avoid the spraying of liquid refrigerant on the skin or splashing of such refrigerant into eyes; if the liquid refrigerant is accidentally sprayed on the skin, please use soap water to clean the skin immediately; if the refrigerant is accidentally splashed into eyes, please use clean water to flush the eyes immediately and consult with a doctor.

Attentions: Do not use open flame to heat or use container not designed for holding of refrigerant to fill refrigerant, for it may cause explosion due to overpressure.

Installation Position

- 1: The unit must be installed on a horizontal and firm concrete ground. Rubber pad can be added to reduce vibration and noise.
- 2: The installation position of the unit shall be kept far away from noise sensitive places like bedroom and study. (The noise generated by the unit is within a normal range).
- 3: The unit shall be installed in a well-ventilated position which is not blocked by barriers.
- 4: The drainage around the installation position shall be in good condition to make sure the water will not flow into the aisle, for it may result in water accumulation and freezing. (During operation of the unit under a cold environment with high humidity will generate abundant condensate water).
- 5: It is prohibited to install the unit in environments with abundant dust, oil dirt, and combustible, explosive and corrosive gases.
- 6: If the unit is operated under an environment with temperature below 0°C for a long time, it shall be guaranteed that the installation position is at least 300mm above the ground to avoid the influence on unit performance due to snow accumulation and coverage.
- 7: Avoid installing the unit in place where strong wind blows directly (as shown in Figure B), for it will lower the capacity and efficiency of the unit. An isolating device may be increased to prevent wind, snow and rain from entering the unit; however, the isolating device shall not compromise the ventilation of the unit.
- 8: A proper distance shall be kept between unit and building to make sure the unit has a sufficient repair space.

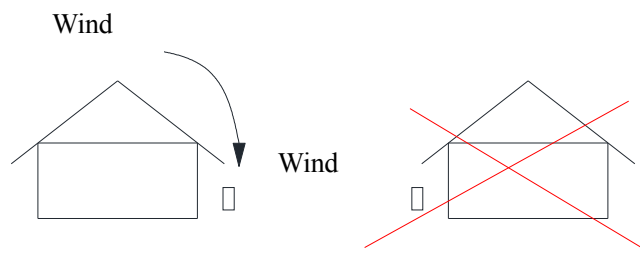
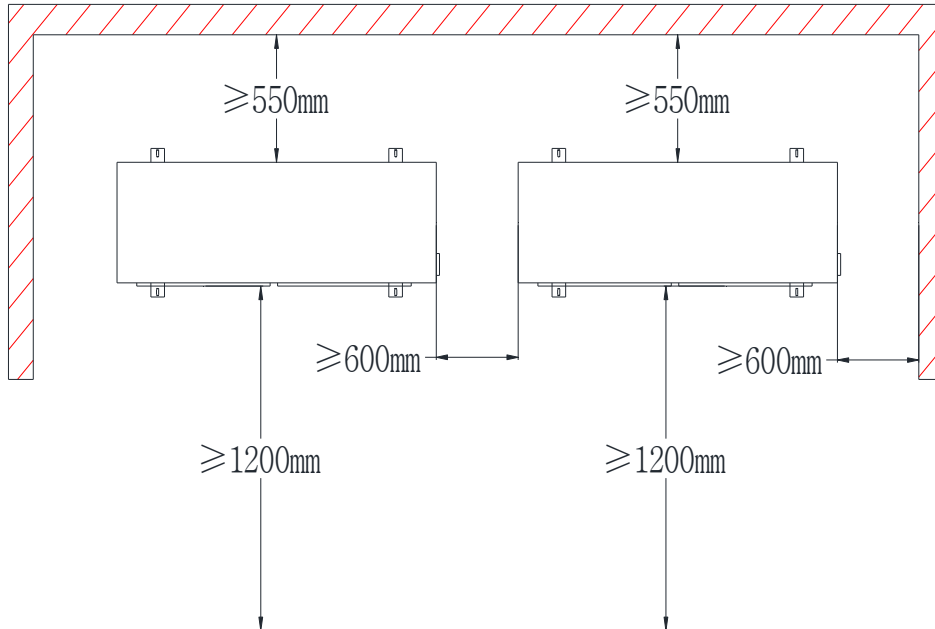

Figure B

Installation Layout

Outdoor unit



Indoor unit

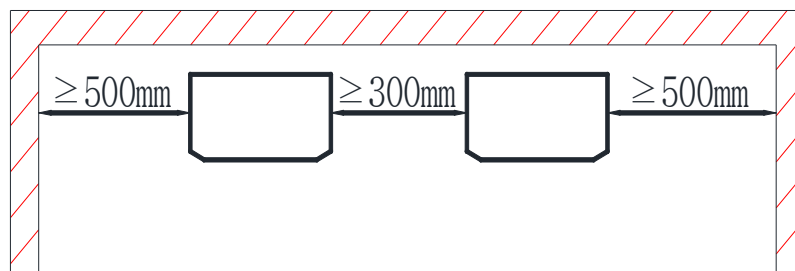
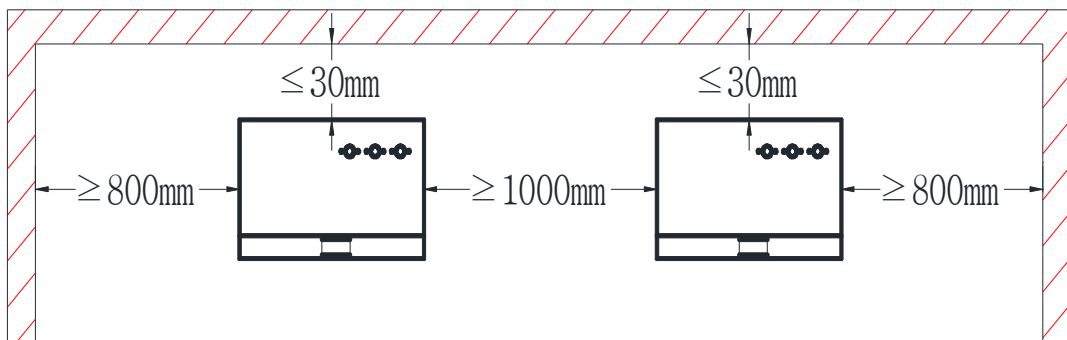

Antifreeze Protectio

Despite complete antifreeze protection inside the unit, it is also possible that plate type

heat exchanger, pipeline and water pump may suffer from frost damage under an extremely cold environment.

Instructions to Installation Position of the Unit in Frost Vulnerable Regions

To avoid water freezing in the system, the following precautionary measures shall be adopted in winter:

- 1: Discharge the water in the pipeline of the unit from the water outlet.
- 2: Add ethylene glycol antifreeze solution of correct proportion in the system.
- 3: The power supply of the unit must be connected all the time to enable the unit to automatically start the circulating water pump and auxiliary heater to prevent freezing.
- 4: The water in the system must be discharged on holidays to avoid the water being frozen during shutdown period.

Important Tips









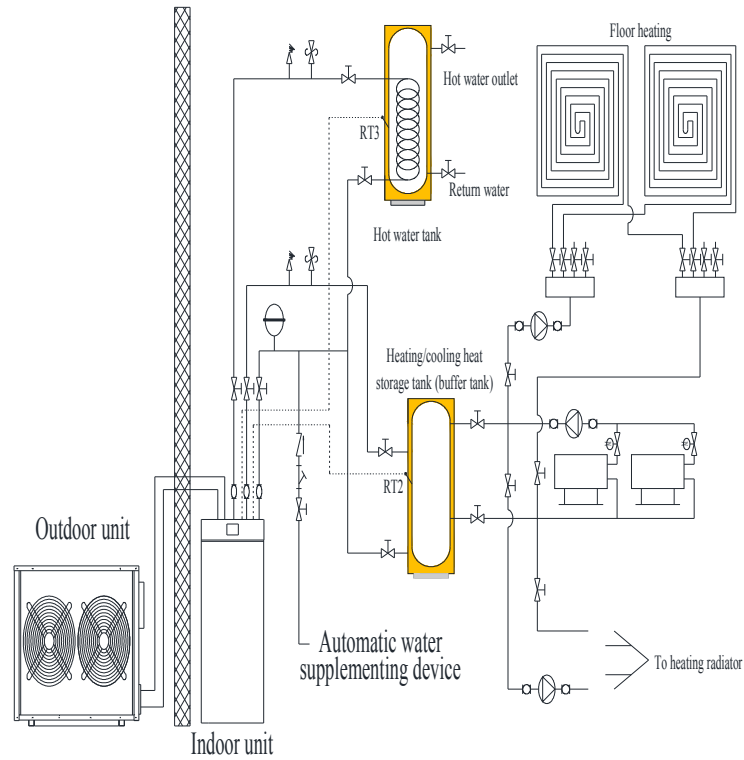

The pipeline must be clean and free from impurity before connection to avoid pollutants from damaging system parts.

The water pressure in the system shall not exceed 500KPa or 72 psi.

System Connection

Diagram of Connection









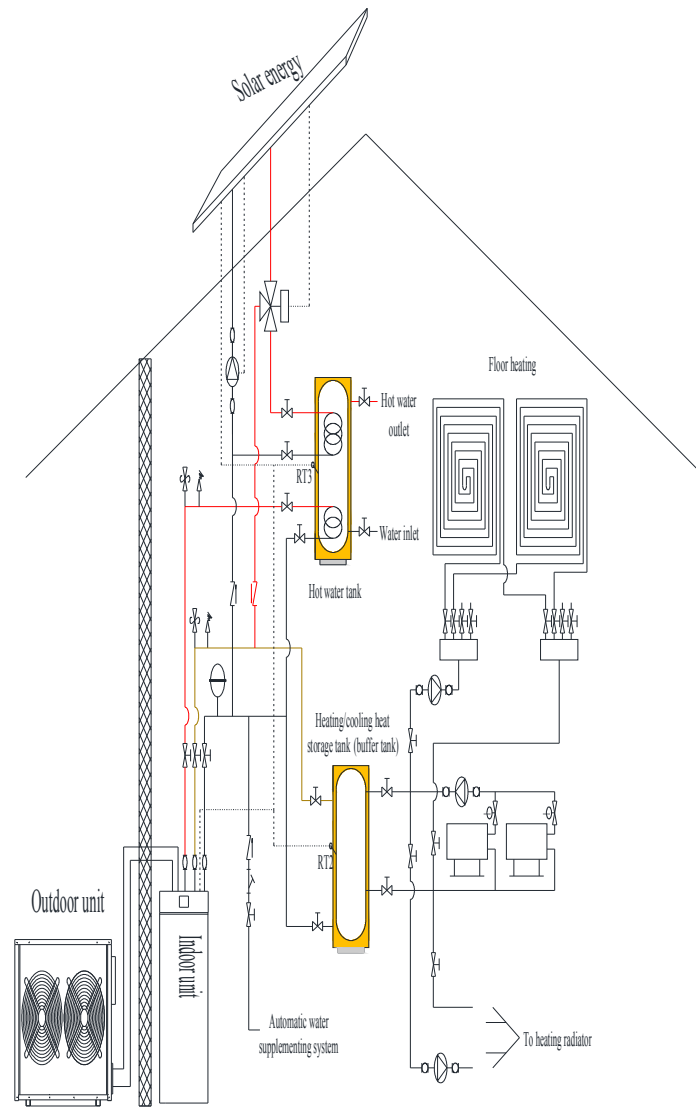



	Expansion tank		One-way valve
	Flexible joint		Solenoid valve
	Safety valve		Vent valve
	Stop valve		Water pump
	Filter		Fan coil

System Connection

Diagram of Connection









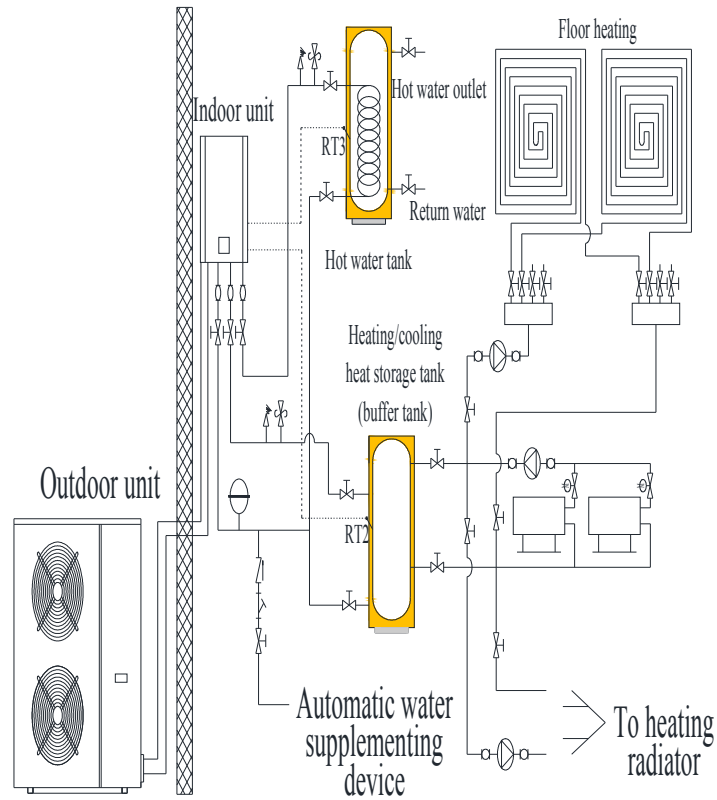



	Expansion tank		One-way valve		Electric three-way valve
	Flexible joint		Solenoid valve		Filter
	Safety valve		Vent valve		Fan coil
	Stop valve		Water pump		

System Connection

Diagram of Connection



	Expansion tank		One-way valve
	Flexible joint		Solenoid valve
	Safety valve		Vent valve
	Stop valve		Water pump
	Filter		Fan coil

System Introduction

Control Principle

Heating Mode

Under heating mode, electric three-way valve AB-A inside the unit is connected.

When it is set to automatic heating, the unit will run according to heating curve. When it is set as manual heating, the unit will run according to the temperature set on the wire controller. The temperature is set within a range of 18-65°C and the initial set temperature is 25°C.

- Under manual heating mode, the unit decides to start or stop based on water temperature of buffer tank and set temperature.
- Under automatic heating mode, the unit will start or stop when the return difference temperature and degree score are satisfied under any condition. If the ambient temperature is within the range of initial temperature of the curve, the unit will start according to the degree score. The calculation of degree score starts when the compressor is shut down or just powered on. The difference between water temperature of buffer tank and set temperature shall be detected once every minute (When degree score = Difference in first minute + Difference in second minute + ≤ -60°C, the unit will start).
- Under manual mode and when the conditions above are not fulfilled, the unit will start based on the relation between actual water temperature and set temperature and return difference.
- The unit shuts down when the actual water temperature exceeds the set temperature.

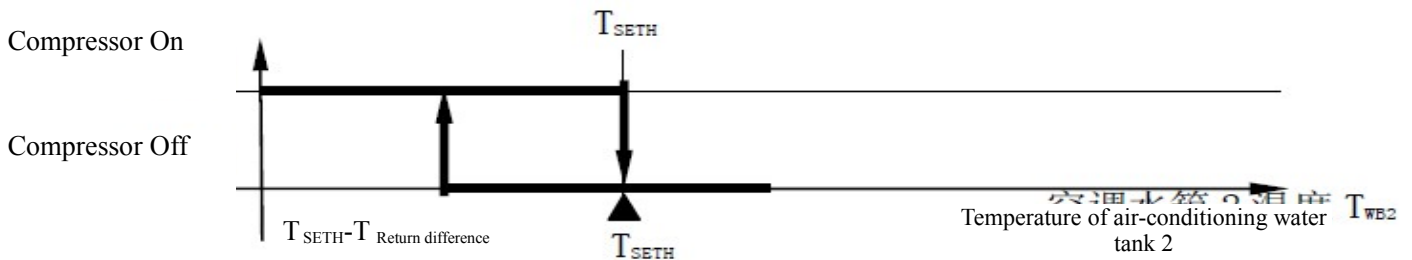

Cooling Mode

Under cooling mode, electric three-way valve AB-A inside the unit is connected.

The range of set cooling temperature is 8-18°C and the initial set temperature is 12°C.

The unit decides to start or stop based on water temperature of buffer tank and set cooling temperature:

System Introduction

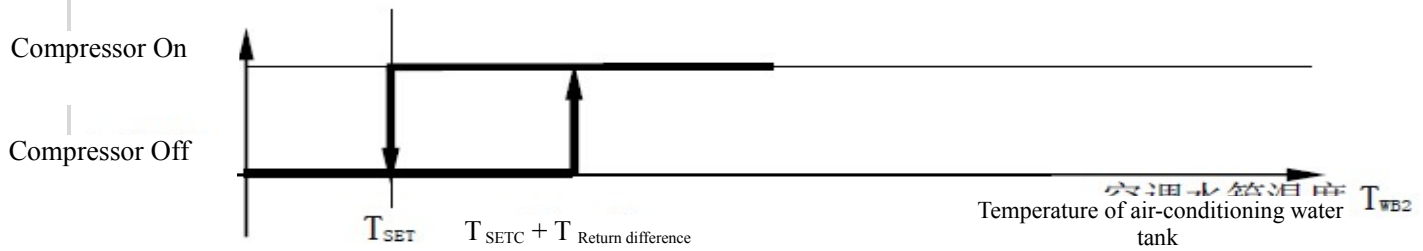

Water Heating Mode (electrical heating function of hot water tank is provided)

Under water heating mode, electric three-way valve AB-B inside the unit is connected.

The range of set heating temperature of water tank is 30-60°C and the initial set temperature is 50°C.

The unit decides to start or stop according to water temperature of hot water tank and set heating temperature:

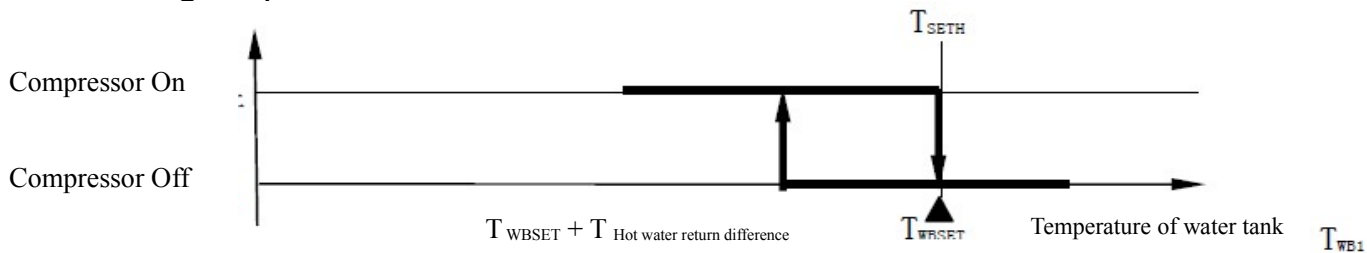

Other Control Functions

High-temperature Disinfection Functions:

- The cycle of high-temperature disinfection is once every 7 days;
- The unit forcefully starts electrical heating of hot water tank during high-temperature disinfection;
- When the water temperature of hot water tank is at least 65°C for 15 continuous minutes, the unit will exit from high-temperature disinfection;
- After the unit enters high-temperature disinfection, if the water temperature of hot water tank is lower than 65°C for 3 continuous hours, the unit will forcefully exit from high-temperature disinfection;
- Long press “Prg” under the main interface for 5 seconds, the unit can forcefully enter high-temperature disinfection;
- Icon “ * ” will be displayed on wire controller during high-temperature disinfection.

System Introduction

Power-down Memorizing Function

- System parameters can be preset. The system will always store the parameters;
- The system is able to memorize startup/shutdown status and electrical heating status;
- Upon power-on after abnormal power failure or shutdown, the system will be in a standby status or maintain the operation status before power-down;

Defrosting

Forced Defrosting:

When the ambient temperature T is not greater than 15°C , and the compressor runs for 10 minutes accumulatively, the unit can enter forced defrosting through wire control operation. Long press “Esc” under the main interface for 5 seconds to enter forced defrosting.

Sensor defrosting (Normal defrosting, i.e. upon no failure occurring in temperature sensor of heating coil):

- Under heating mode, when the ambient temperature T is not greater than 15°C and the accumulated low-temperature operation of compressor reaches the set time of defrosting cycle, if the temperature of heating coil is lower than the set defrosting temperature, the unit will enter defrosting mode;

Notes: The low temperature upon low-temperature timing mentioned here refers to that the temperature of heating coil is lower than the defrosting exit temperature.

The accumulated running time here will be reset after defrosting ends or when the temperature of outer coil is greater than the defrosting exit temperature;

- When the temperature of heating coil is greater than the defrosting exit temperature or the defrosting time reaches the maximum value, it will exit from defrosting;

Timer Defrosting (upon failure of temperature sensor of heating coil):

- When the ambient temperature does not exceed 8°C and the accumulated running time of compressor reaches the set defrosting cycle, it will enter the defrosting mode;

Timer defrosting (upon failure of temperature sensor of heating coil):

- When the ambient temperature does not exceed 8°C and the accumulated running time of compressor reaches the set defrosting cycle, it will enter the defrosting mode;
- After the defrosting time reaches the set defrosting time, it will exit from defrosting;

Abnormal Completion of Defrosting:

- In case of shutdown during defrosting, it will continuously run defrosting and it will only stop running after defrosting ends;
- In case of high-voltage protection during defrosting, it will exit from defrosting and shutdown protection will be triggered;

System Introduction

Clock/Timer On/Off Functions

- The wire controller can set a real-time clock synchronous with real time;
- The wire controller can set timer on/off function;
- Under a standby status, when timer on function is set, and the timer on time is reached, the unit will automatically start to run. The working mode is the previous startup/running mode;
- During startup and running, when timer off function is set and the timer off time is reached, the unit will automatically shut down.

Electrical Heating of Hot Water Tank

When the following conditions are fulfilled simultaneously, the electrical heating of hot water tank is started:

- The unit runs under hot water mode;
- Hot water demand exists (i.e. constant temperature shutdown condition is not reached).

If any of the following conditions is fulfilled, the compressor will be shut down and the electrical heating of hot water tank will be started:

- When ambient temperature T is $\geq -1^{\circ}\text{C}$ and temperature of hot water tank is $\geq 55^{\circ}\text{C}$;
- When ambient temperature T is $\leq -2^{\circ}\text{C}$ and temperature of hot water tank is $\geq 50^{\circ}\text{C}$;
- When protection occurs to the system under hot water mode.

If any of the following conditions is fulfilled, the electrical heating of hot water tank will be shut down:

- The water temperature of hot water tank reaches the temperature for constant temperature shutdown;
- Exit from hot water mode (including working mode exit and protection or exit due to failure shutdown);
- When ambient temperature T is $\geq -1^{\circ}\text{C}$ and temperature of hot water tank $\leq 53^{\circ}\text{C}$, the compressor will be restarted and the electrical heating of hot water tank will be shut down;
- When ambient temperature T is $\leq -2^{\circ}\text{C}$ and temperature of hot water tank is $\leq 48^{\circ}\text{C}$, the compressor will be restarted and the electrical heating of hot water tank is controlled by ambient temperature (when ambient temperature T is $\leq -2^{\circ}\text{C}$, the electrical heating of hot water tank will be started; when ambient temperature T is $> 0^{\circ}\text{C}$, the electrical heating of hot water tank will be shut down).

Note: The electrical heating of hot water tank is forcefully started during high-temperature disinfection.

System Introduction

Electrical Heating of Water Circuit

The electrical heating of water circuit is started if the following conditions are fulfilled:

- The electrical heating of water circuit is started under defrosting mode;
- The electrical heating of water circuit is started under secondary antifreeze in winter;
- Production occurs to the system under heating mode;

The electrical heating of water circuit is shut down if one of the following conditions is fulfilled:

- The electrical heating of hot water tank is started;
- Failure occurs in water switch;
- Exit from defrosting;
- Exit from secondary antifreeze;
- Non-startup heating mode;
- Water temperature of buffer tank $T \geq$ Set heating temperature

Water Pump

- After the system requests for shutdown, the water pump starts 3 minutes earlier than the compressor. The compressor will be started after the water system is fully circulated;
- After the system requests for shutdown, the water pump shuts down only after the compressor is shut down for 5 minutes;
- During defrosting period, the water pump does not stop running;

Notes:

As for common type, when it shuts down under constant temperature, the water pump does not shut down;

As for special type: water pump shuts down after the compressor is shut down for 5 minutes.

Pipeline Connection

1. Local laws, regulations and standards must be followed during pipeline installation.
2. Please refer to the unit label and correctly connect the inlet and outlet pipes of the unit. Wrong water inlet will lower the capacity of the unit and possibly damage the unit.
3. Flexible joint is used to ease the vibration between water pipe and water pump and heat exchanger.
4. The water supply system must be clean and free from abundant sundries that may damage the unit like metal.
5. Control devices like stop valve, safety valve, vent valve, expansion tank and blow-down valve shall be added outside the unit.
6. During pipeline connection and installation, use of elbow shall be avoided as much as possible to reduce flow resistance; the drainage pipeline shall be installed at the lowest place.
7. Flexible connection shall be used as much as possible to reduce vibration.
8. Pipelines exposed outside shall be protected by using thermal insulation pipe to prevent the loss of heat and the condensation of condenser pipe.
9. Water shall be filled to the system to eliminate the residual air in the system.
10. Since no stop valve is installed in the unit, stop valve shall be installed outside the unit to facilitate maintenance.

Pipeline Connection

Connecting refrigerant pipe (not supplied)

Install the refrigerant pipes between the outdoor unit and indoor unit.

Installation must be carried out in accordance with current norms and directives.

- If indoor unit is higher than outdoor unit more than 5m, an oil return curve must be made in each 5m .
- Max. height difference between indoor and outdoor unit (H) :10m
- Max. pipe length (L) : 15m

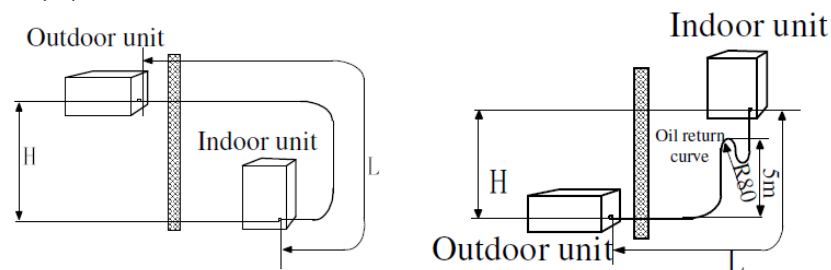

	Gas pipe	Liquid pipe
Pipe size	Φ9.52mm (3/8 ")	Φ19mm (3/4 ")
Connection	Flare(3/8 ")	Flare((3/4 ")

Minimum copper coil thickness	1.0mm	1.5mm
Max pressure	4.5MPa	

Flare connections Expansion

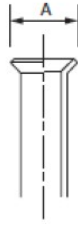

Outer diameter, copper pipe (mm)	A(mm)
Φ9.52	13.2
Φ19	22.83

Pipeline Connection

Ejection

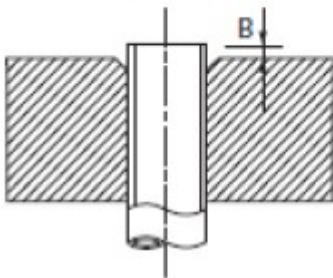

Outer diameter, copper pipe (mm)	B, with an R410A tool (mm)	B, with a conventional tool (mm)
Φ9.52	0~0.7	1~1.5
Φ19		

- Service valves on indoor/outdoor pipe connector should close when connecting the pipes. The indoor/outdoor pipe connector refer to Chapter “components”
- Ensure that water and dirt does not enter the pipes.
- Bend the pipes with as large a radius as possible (at east R100~R150). Do not bend a pipe repeatedly. Use a bending tool.
- Connect the flare connector and tighten to the following torque.

Pipe diameter	Torque
3/8 " (Φ9.52mm)	30-40 (N·m)
3/4 " (Φ19mm)	65-80 (N·m)

- Aim the flare connection of copper coil at the center of screw connection of heat pump , screw the flare nut as tightly as possible manually.
- Tighten the flare nut to required torque with a torque wrench

Pipeline Connection

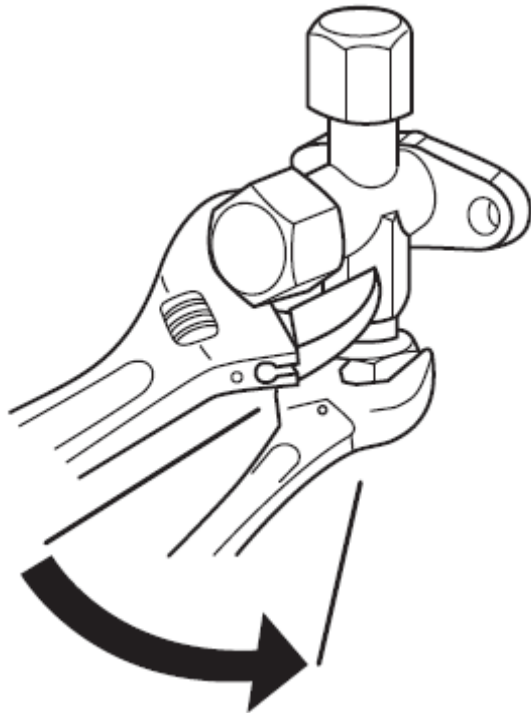

Pressure test and leak test

The pipe connection between indoor and outdoor unit must be pressure tested and leak tested after installation.

Only nitrogen could be used when pressurizing and flushing the system.

Use a vacuum pump to evacuate all air. Vacuum for at least one hour and end pressure after evacuation must be 1mbar absolute pressure.

If the system has remaining moisture or a leak, the vacuum pressure will rise after completed evacuation.

Pipeline Connection

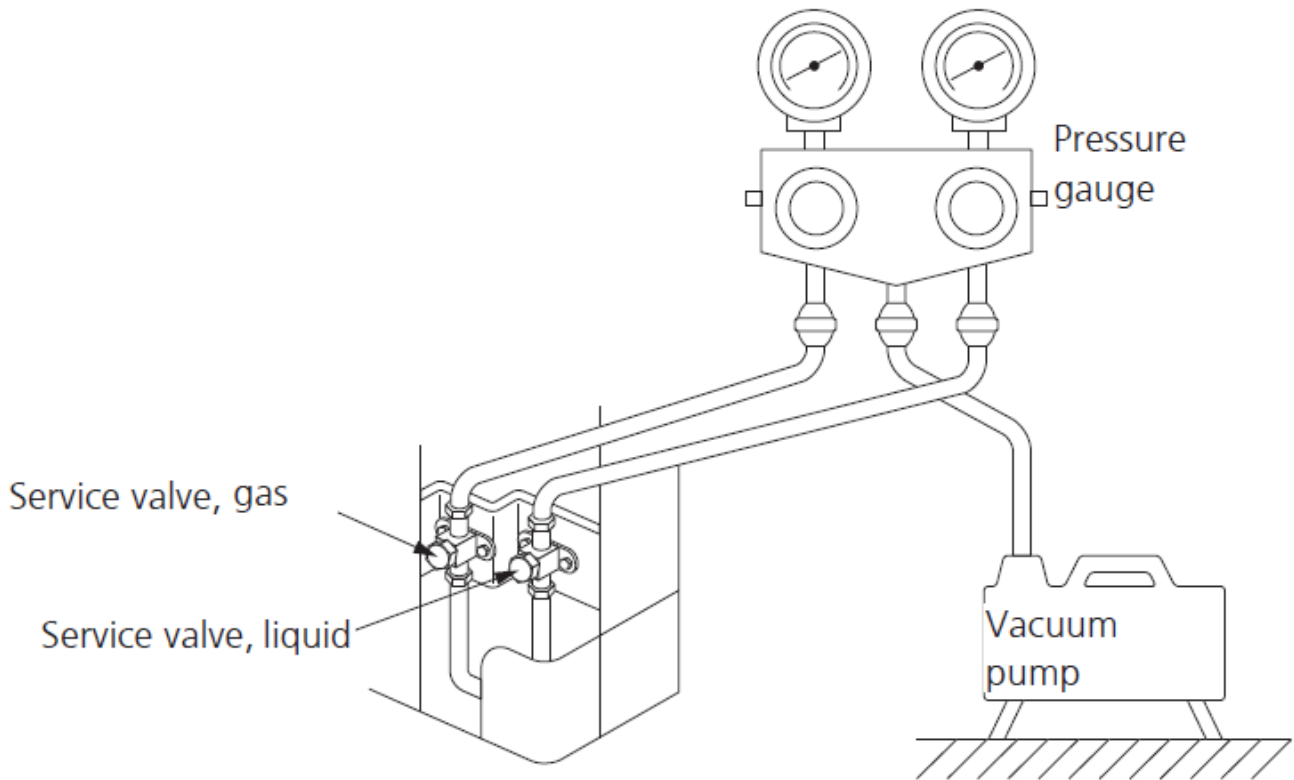

Filling refrigerant:

After finishing pipe connections, pressure test ,leak test and vacuuming, the service valves can be opened.

The gas inside the indoor unit is enough for 5m pipe. If connection pipe is longer than 5m, need to re-fill some R410A refrigerant. Filling weight is 50g per extra meter.

Insulating refrigerant pipes

Insulate refrigerant pipes for heat insulation and to prevent condensate.

Use insulation that can withstand at least 120°C.

The insulation should be at least 13 mm thick.

Pipeline Connection

Principle:

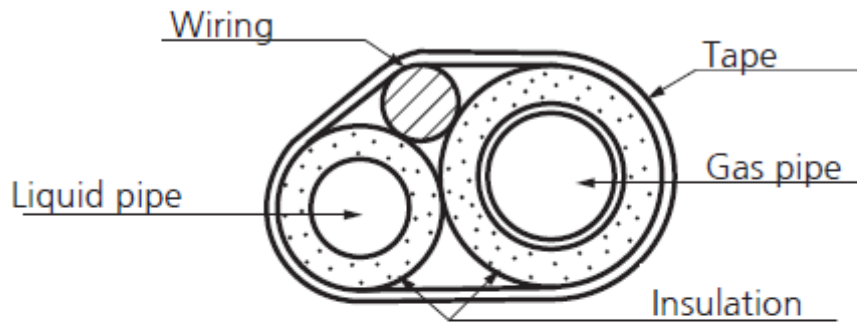

Connections:

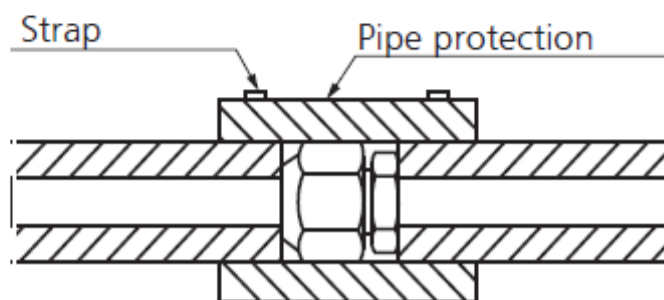

NOTE!

The pipe work must be flushed before the heat pump is connected, so that any contaminants do not damage the components parts.

The water pressure in the heat exchanger can not exceed 0.5Mpa

Electrical Connection

Wiring Diagram

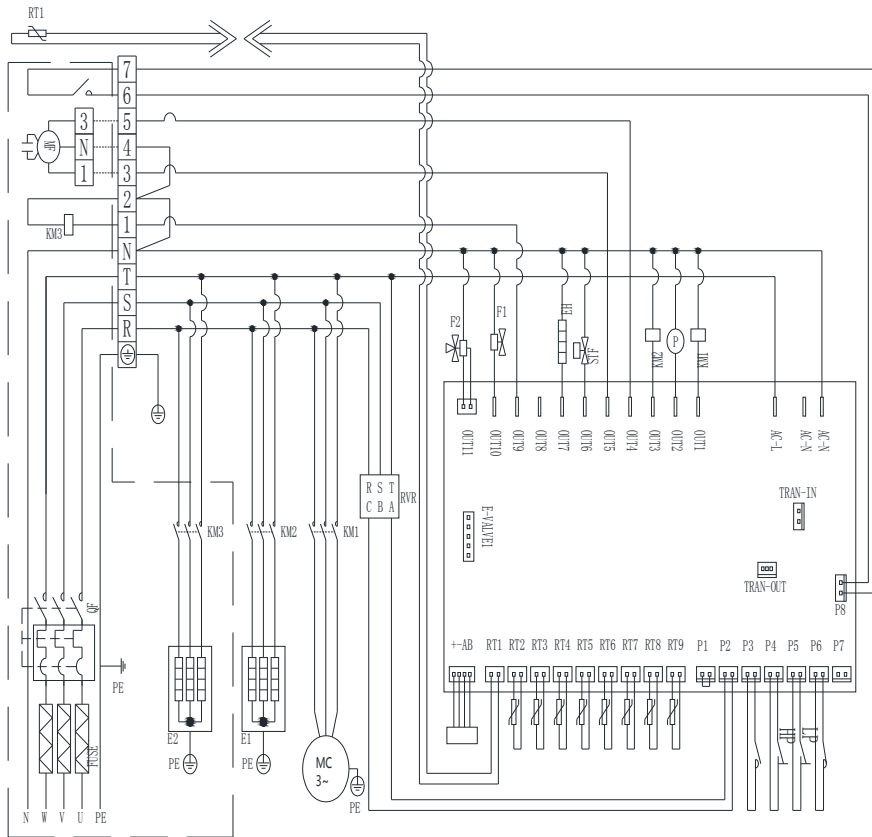

Instructions

KM1---AC contactor of compressor

KM2---Electrical heating AC contactor of water circuit

E1---Electrical heating of water circuit

E2---Electrical heating of hot water tank (prepared by users themselves when necessary)

KM3---Electrical heating AC contactor of hot water tank (prepared by users themselves when necessary)

F1---Enthalpy added solenoid valve

F2---Electric three-way valve

MF---Fan

Electrical Connection

EH---Crankcase heater of compressor

RVR---Phase sequence protector

RT1---Ambient temperature sensor

RT2---Temperature sensor of buffer tank

RT3---Temperature sensor of hot water tank

RT4---Discharge temperature sensor

RT5---Back temperature sensor

RT6---Temperature sensor of cooling coil

RT7---Temperature sensor of heating coil

RT8---Outlet water temperature sensor

RT9---Inlet water temperature sensor

HP---High-voltage switch

LP--- Low-voltage switch

Description of Wiring

The parts inside the dashed box shall be prepared by users themselves. Terminal blocks R/S/T/N are connected to 380V three-phase four-wire power input; 1 and 2 are connected to electrical heating AC contactor coil of hot water tank (this terminal outputs 220V/50Hz/5A power supply. The users may configure, install and connect this terminal by themselves). It can also be used as the control power supply of other heat sources. However, an AC contactor must be connected; 3-4-5 are connected to Outdoor unit fan . 6 and 7 are connected to cooling/heating demand switch (it shall be connected to supporting facilities and parts).

Electrical Connection

Ambient temperature sensor (RT1)

One section of RT3 probe is inside the outdoor unit control box. Other section of RT3 probe is inside the indoor unit control box. Connect two section of RT3 probe with its connector.

Temperature Sensor of Buffer Tank (RT2)

One end of the temperature sensor of buffer tank is already connected to RT2 port of control panel upon leaving the factory. The other end shall be put into the temperature measuring port of the buffer tank and sealed upon installation to prevent the formation of condensate water from influencing the measured value of temperature.

Hot Water Temperature Sensor (RT3)

One end of hot water temperature sensor is already connected to RT3 port of control panel upon leaving the factory. The other end shall be put into the temperature measuring port of the hot water tank and sealed upon installation to prevent the formation of condensate water from influencing the measured value of temperature.

Room Cooling/Heating Demand Switch

Terminal 6 and terminal 7 are signal inputs of room cooling/heating demand switch. When terminal 6 and terminal 7 are disconnected, the cooling/heating (air-conditioning) function will be shut down; when terminal 6 and terminal 7 are connected, the cooling/heating (air-conditioning) function will be enabled. External signals like timer or temperature controller can also be used to control the connection and disconnection of terminal 6 and terminal 7 so as to realize the enabling and shutdown of the cooling/heating (air-conditioning) function.

Attentions:

Terminal blocks 6 and 7 of the unit can only be used to connect external switching signals. Do not connect to AC power supply.

Electrical Connection

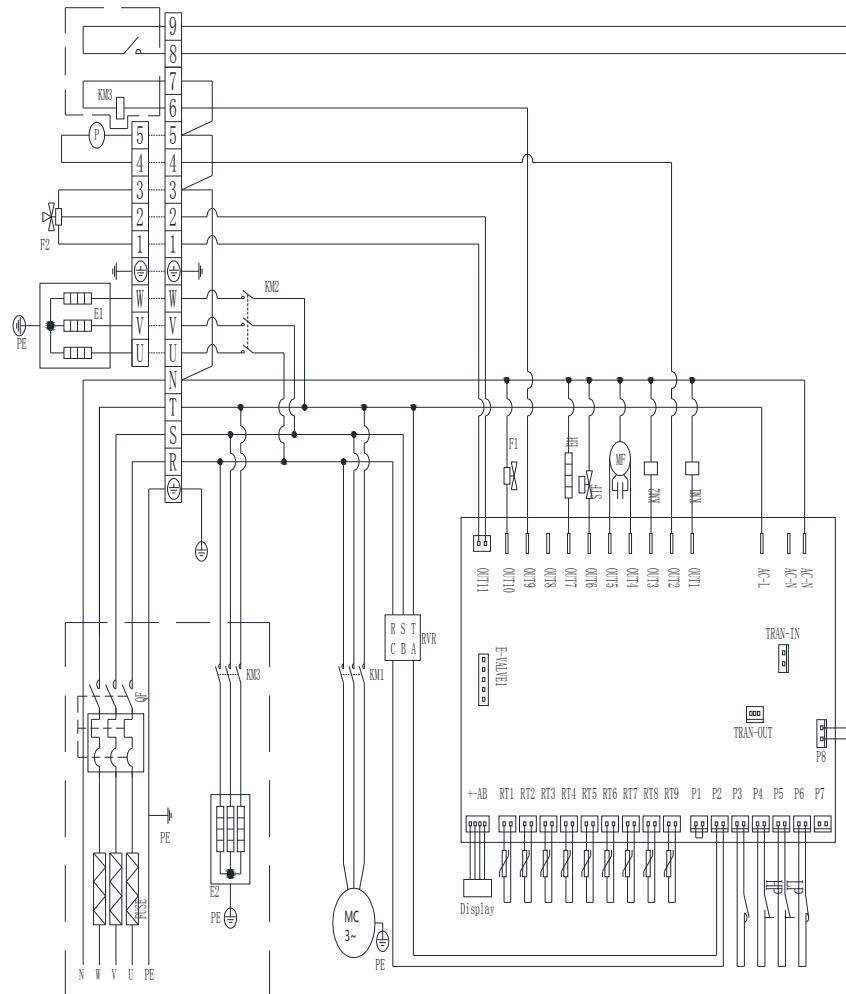

Instructions

KM1---AC contactor of compressor

KM2---Electrical heating AC contactor of water circuit

E1---Electrical heating of water circuit

E2---Electrical heating of hot water tank (prepared by users themselves when necessary)

KM3---Electrical heating AC contactor of hot water tank (prepared by users themselves when necessary)

F1---Enthalpy added solenoid valve

F2---Electric three-way valve

MF---Fan

Electrical Connection

EH---Crankcase heater of compressor
RVR---Phase sequence protector
RT1---Ambient temperature sensor
RT2---Temperature sensor of buffer tank
RT3---Temperature sensor of hot water tank
RT4---Discharge temperature sensor
RT5---Back temperature sensor
RT6---Temperature sensor of cooling coil
RT7---Temperature sensor of heating coil
RT8---Outlet water temperature sensor
RT9---Inlet water temperature sensor
HP---High-voltage switch
LP--- Low-voltage switch

Description of Wiring

The parts inside the dashed box shall be prepared by users themselves. Terminal blocks R/S/T/N are connected to 380V three-phase four-wire power input; 1-2-3 are connected to Electric three-way valve. 4 and 5 are connected to hot water pump. 6 and 7 are connected to electrical heating AC contactor coil of hot water tank (this terminal outputs 220V/50Hz/5A power supply. The users may configure, install and connect this terminal by themselves). It can also be used as the control power supply of other heat sources. However, an AC contactor must be connected; 8 and 9 are connected to cooling/heating demand switch (it shall be connected to supporting facilities and parts).

Electrical Connection

Temperature Sensor of Buffer Tank (RT2)

One end of the temperature sensor of buffer tank is already connected to RT2 port of control panel upon leaving the factory. The other end shall be put into the temperature measuring port of the buffer tank and sealed upon installation to prevent the formation of condensate water from influencing the measured value of temperature.

Hot Water Temperature Sensor (RT3)

One end of hot water temperature sensor is already connected to RT3 port of control panel upon leaving the factory. The other end shall be put into the temperature measuring port of the hot water tank and sealed upon installation to prevent the formation of condensate water from influencing the measured value of temperature.

Room Cooling/Heating Demand Switch

Terminal 8 and terminal 9 are signal inputs of room cooling/heating demand switch. When terminal 8 and terminal 9 are disconnected, the cooling/heating (air-conditioning) function will be shut down; when terminal 8 and terminal 9 are connected, the cooling/heating (air-conditioning) function will be enabled. External signals like timer or temperature controller can also be used to control the connection and disconnection of terminal 8 and terminal 9 so as to realize the enabling and shutdown of the cooling/heating (air-conditioning) function.

Attentions:

Terminal blocks 8 and 9 of the unit can only be used to connect external switching signals. Do not connect to AC power supply.

Electrical Connection

- Protective circuit breaker must be installed according to the maximum value stipulated in the nameplate of the unit.
- Single-phase or three-phase power supply may be adopted in the unit. The specification of power supply must meet the requirements of the nameplate. The wiring must be connected according to the wiring diagram.
- An independent leakage protector shall be equipped in the unit.

Warnings:

Electrical installation and service must be conducted under the supervision of qualified electrician. The electrical installation and wiring must comply with local laws and regulations.

The switch of main power supply shall be disconnected before repair.

In case of a major failure, the host shall be closed and the power supply shall be disconnected. Then, contact with local after-sales service for maintenance. Do not repair it by yourself.

Attentions:



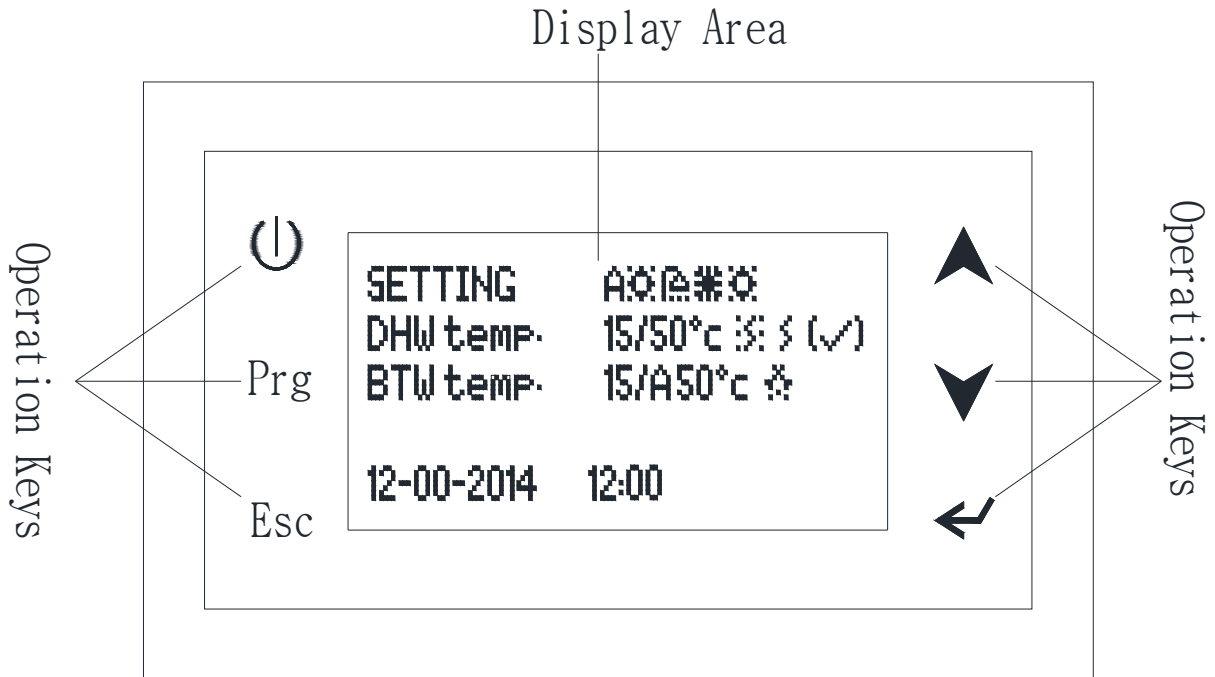

During installation of the unit, the water circuit shall be connected first and the electrical circuit shall be connected later to lower the danger of electric shock.

All temperature sensors shall be at least 200mm away from power cable to prevent the influence of power supply fluctuation on the accuracy of temperature measurement.

Control



Operation Keys









	On/Off key: Long press it for 2 seconds to switch startup/shutdown.
Prg	Menu key: Press this key in the main interface to enter the menu; long press it for 5 seconds to begin manual disinfection.
Esc	Return key: Press the button to return to previous menu and confirm to modify parameter after entry into the menu; long press the main interface for 5 seconds to conduct forced defrosting.
	Up key: Modify parameter or turn to previous page.
	Down key: Modify parameter or turn to next page.
	Enter key: Press this key to enter the next level of parameters or enter parameter modification status. Long press the main interface for 5 seconds to lock/unlock.

Control

Display Area

- The first line of the display area displays the unit running mode.
- The second line of the display area displays temperature of hot water tank, set temperature and running status of electrical heating.
- The third line of the display area displays the temperature of heating/cooling water tank and set temperature.
- If terminal 5 and terminal 6 are disconnected, the third line will display blinking to indicate the shutdown of heating/cooling function.

Description of Icons

	Heating mode		Electrical heating operation
	Cooling mode		High-temperature disinfection
	Water heating mode		Defrosting
	Automatic heating		Current running mode of unit

Meanings of System Parameters

Menu	Submenu	Meaning	Range of parameter	Remark
Function setting				
Mode select	DHW	Water heating mode	On/Off	Adjustable
	BTW	Heating/cooling mode	Off/Cooling/Heating/Auto heating	Adjustable
	DHW temp.	Set temperature of water heating	30~60°C	Adjustable
	BTW temp.	Set heating/cooling temperature	18~65°C/8~18°C	Adjustable
	Initial BTW temp.	Initial temperature of automatic heating curve	15~25°C	Adjustable
	Heating curve	Selection of automatic heating curve	24~50°C	Adjustable,

Control

Meanings of System Parameters

Menu	Submenu	Meaning	Range of parameter	Remark
Function setting				
Unit status	DHW temp.	Temperature of hot water tank	-30~99°C	Measured value
	BTW temp.	Temperature of heating/cooling water tank	-30~99°C	Measured value
	BTW inlet temp.	Heating/cooling inlet temperature	-30~99°C	Measured value
	BTW outlet temp.	Heating/cooling outlet temperature	-30~99°C	Measured value
	Heating coil	Temperature of heating coil	-30~99°C	Measured value
	Cooling coil	Temperature of cooling coil	-30~99°C	Measured value
	Exhaust coil	Exhaust temperature	0~125°C	Measured value
	Evap. Temp	Evaporation temperature	-30~99°C	Measured value
	Ambient temp.	Ambient temperature	-30~99°C	Measured value
	Expansion valve	Step number of electronic expansion valve	100~480N	Measured value
Parameter setting				
System parameter	DHW ΔT	Set temperature of water heating return difference	1~20°C	Adjustable
	BTW ΔT	Set temperature of air conditioning return difference	1~20°C	Adjustable
	EEV Overheat/H	Targeted degree of superheat	-20~20°C	Adjustable
	Comp.start	Startup delay of compressor upon initial power-on	1~10M	Adjustable
	BTW pump	Water pump mode	Special/Normal	Adjustable
	Disinfection	High-temperature disinfection or not	On/Off	Adjustable
	EH mode	Selection of opening of electrical heating of water circuit		

Control

Meanings of System Parameters

Menu	Submenu	Meaning	Range of parameter	Remark
Parameter setting				
System parameter	EH mode	Selection of startup of electrical heating of water circuit	0 (Auto)/1 (Ambient)/2 (Water temperature)/3 (Ambient + Water temperature)	Adjustable
	EH start temp.	Ambient temperature upon manual startup of electrical heating of water circuit	-17~7°C	Adjustable
	BTW Δ T EH	Return difference of air-conditioning water temperature upon manual startup of electrical heating of water circuit	0~15°C	Adjustable (This return difference + Air-conditioning return difference)
	DHW Δ T EH	Return difference of hot water temperature upon startup of electrical heating of water tank	0~20°C	Adjustable (This return difference + Water heating return difference)
	EH start	Startup delay of electrical heating of water tank	10~90Min	Adjustable
Defrost parameter	Def. cycle	Defrosting cycle	2min~90min	Adjustable
	Def. start temp.	Defrost start temperature	-20-5°C	Adjustable
	Def. stop temp.	Defrost stop temperature	1°C~30°C	Adjustable
	Def. Max. time	Maximum defrosting time	1min~12min	Adjustable
	Def.elec.heater	Electrical heating started for defrosting or not	ON/OFF	Adjustable

Control

Meanings of System Parameters

Menu	Meaning	Remark	
Failure records	Record recent 8 failures	Only for inquiry	
Time setting	Date	Date	Adjustable
	Clock	Clock	Adjustable
	Timer on	Timer on	Adjustable
	Timer off	Timer	Adjustable
Temp. curve display	BTW temp.	Temperature curve of air-conditioning water tank	Measured value
	DHW temp.	Temperature curve of hot water tank	Measured value
	Ambient temp.	Ambient temperature curve	Measured value

Initial Interface (as shown in the following diagram)

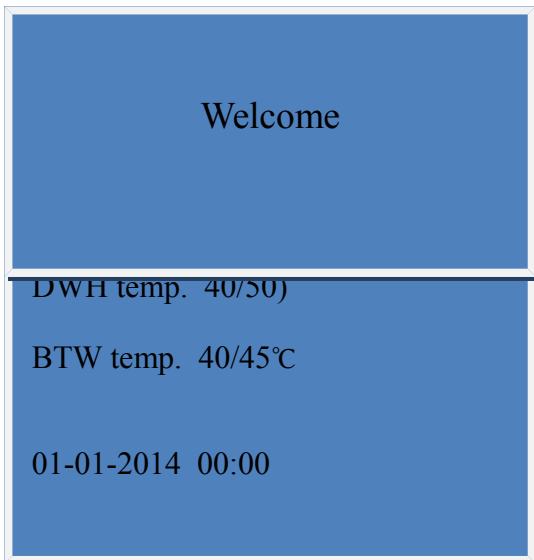

(as shown in the following diagram)

Control

Start Interface (as shown in the following diagram)

SETTING Unit running mode icon

DWH temp. 40/50°C (√)

BTW temp. 40/45°C

01-01-2014 00:00

following diagram. Once a failure occurs to the relevant failure code and part where the failure

occurs.

Failure display



E11
Low pressure
Protection

ng
status to enter main menu interface.

Parameter setting
Failure records
Time setting
Temp. curve display

Control

Press “” to confirm the choice and enter next menu.

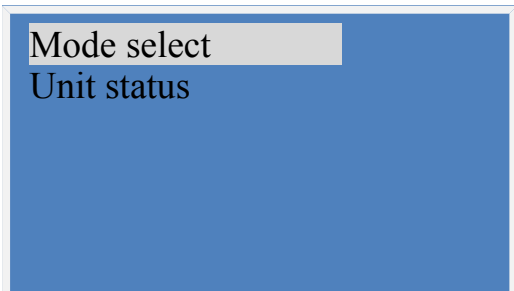

choice and enter next menu.

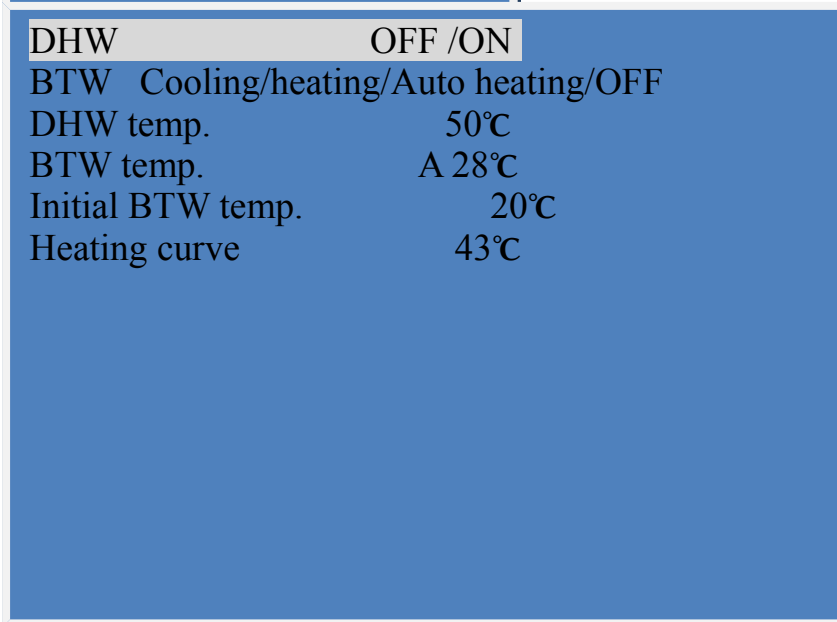

ify and press “” to confirm the

nd “” to select set temperature to

modify this parameter. At this point, this

increase or decrease the set temperature

and press “Esc” to confirm modification; press “Esc” again to return to previous menu.

Control

Query of Unit Running Status

Press “Prg” under startup or standby status to enter main menu interface.

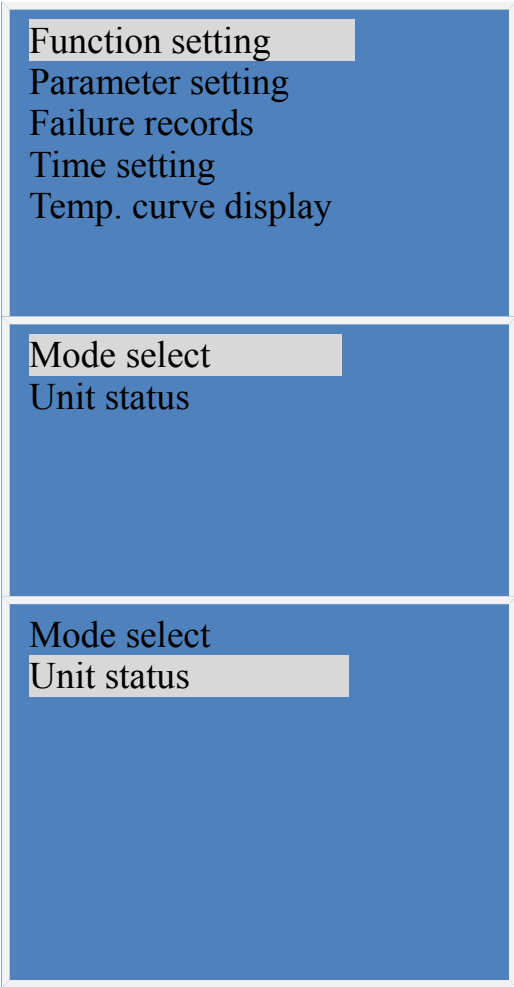

and enter next menu.

Control

Press “” to confirm the choice and enter next menu.

DHW temp.	14°C
BTW temp.	14°C
BTW inlet temp.	14°C
BTW outlet temp.	14°C
Heating coil	14°C
Cooling coil	14°C
Exhaust coil	14°C
Evap. Temp	14°C
Ambient temp.	14°C
Expansion valve	480N

Check the running status of the unit.

Warnings:

Parameters under this menu are already set upon leaving the factory. The users shall not set them by themselves. Otherwise, failure can occur to unit operation and even damage the unit.

Control

Press “Prg” under startup or standby status to enter main menu interface.

Function setting
Parameter setting
Failure records
Time setting
Temp. curve display

Function setting
Parameter setting
Failure records
Time setting
Temp. curve display



1.0 System parameter
2.0 Defrost parameter

Press the right arrow key and enter next menu.

Press the right arrow key and enter parameter setting.

Control

1.1 DHW ΔT	5°C
1.2 BTW ΔT	2°C
1.3 EEV Overheat/H	3°C
1.4 Comp. start	1M
1.5 BTW pump	Special/Normal
1.6 Disinfection	ON/OFF
1.7 EH mode	0/1/2/3
1.8 EH start temp.	-5°C
1.9 BTW ΔT EH	2°C
1.10 DHW ΔT EH	5°C
1.11 EH start	30M

to modify and press “” to confirm the choice
this parameter begins to blink. Press “” and “”
“Esc” to confirm modification; press “Esc” again to

Warnings:

Parameters under this menu are already set upon leaving the factory. The users shall not set them by themselves. Otherwise, failure can occur to unit operation and even damage the unit.

Control

Press “Prg” under startup or standby status to enter main menu interface.

Function setting
Parameter setting
Failure records
Time setting
Temp. curve display

Function setting
Parameter setting
Failure records
Time setting
Temp. curve display

1.0 System parameter
2.0 Defrost parameter

1.0 System parameter
2.0 Defrost parameter

Press the right arrow key and enter next menu.

Control

Press “←” to confirm the choice and enter defrost parameter setting.

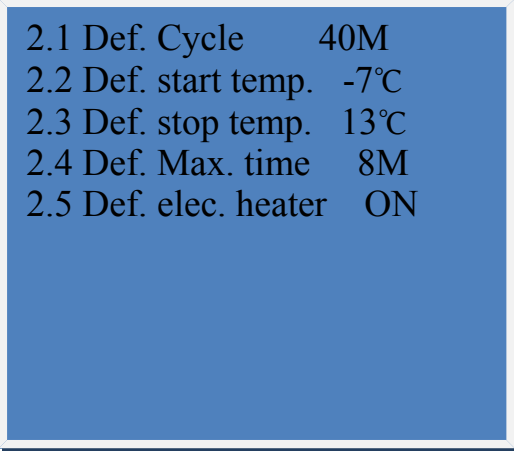

A screenshot of a menu with a blue background. The text is as follows:

- 2.1 Def. Cycle 40M
- 2.2 Def. start temp. -7°C
- 2.3 Def. stop temp. 13°C
- 2.4 Def. Max. time 8M
- 2.5 Def. elec. heater ON

parameter to modify and press “←” to confirm the choice. At this point, this parameter begins to blink. Press “▲” and “▼” to move between parameters and press “Esc” to confirm modification; press “Esc” again to

return to previous menu.

Query of Failure Records

Press “Prg” under startup or standby status to enter main menu interface.

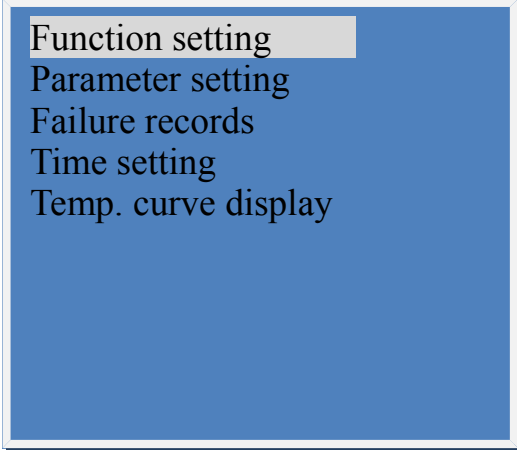

A screenshot of a main menu interface with a blue background. The text is as follows:

- Function setting
- Parameter setting
- Failure records
- Time setting
- Temp. curve display

Control

Function setting
Parameter setting
Failure records
Time setting
Temp. curve display

and enter query of failure records; at most 8 failures can be
previous menu.
/off.
by status to enter main menu interface.

Function setting
Parameter setting
Failure records
Time setting
Temp. curve display

Function setting
Parameter setting
Failure records
Time setting
Temp. curve display

Control

Press “←” to confirm the choice and enter parameter menu.

Date	01-01-2014
Clock	00:00
Timer on	×/√ 00:00
Timer off	×/√ 00:00

Select date item and press “←” to confirm the choice and parameter will cycle according to the following pattern each time the parameter blinks, press “▲” and “▼” to modify this

parameter until completion of parameter setting. Press “Esc” to return to previous menu.

Date → Month → Year → Setting completed

2. Modification of Clock

Press “▲” and “▼” to select clock item and press “←” to confirm the choice and modify this parameter. Then, the parameter will cycle according to the following pattern each time “←” is pressed. When the parameter blinks, press “▲” and “▼” to modify this parameter until completion of parameter setting. Press “Esc” to return to previous menu.

Hour → Minute → Setting completed

3. Timer On

Press “▲” and “▼” to select timer on item and press “←” to confirm the choice and modify this parameter. Then, the parameter begins to blink. Press “▲” and “▼” to modify this parameter and press “←” again to open or close timer on function.

Control

When it is selected to open timer on function, the parameter will cycle according to the following pattern each time “←” is pressed. When the parameter blinks, press “▲” and “▼” to modify this parameter until completion of parameter setting. Press “Esc” to return to previous menu.

Hour → Minute → Setting complete → Open/close timer on

4. Timer Off

Press “▲” and “▼” to select timer off item and press “←” to confirm the choice and modify this parameter. Then, the parameter begins blink. Press “▲” and “▼” to modify this parameter and press “←” again to open or close timer off function.

When it is selected to open timer off function, the parameter will cycle according to the following pattern each time “←” is pressed. When the parameter blinks, press “▲” and “▼” to modify this parameter until completion of parameter setting. Press “Esc” to return to previous menu.

Hour → Minute → Setting complete → Open/close timer off

Warnings

Phase Sequence Protection

- After power-on for 5 seconds, if the phase sequence protection switch is continuously disconnected for 3 seconds as detected at any moment, shutdown protection will be triggered and report phase sequence failure;
- If this failure occurs for three times within 30 minutes, the unit will not be recoverable unless powered down;
- The wire controller will report failure repair upon phase sequence failure;
- Water pump starts. Electrical heating starts when set water temperature is not reached.

Water Flow Failure

- Detect water switch after the water pump is started for 40 seconds. If it is detected that this switch is disconnected for 15 continuous seconds, shutdown protection will be triggered;
- After this failure occurs, if the failure does not recover, the water pump will be restarted for operation every 3 minutes to detect water flow. When this failures occurs for 5 times continuously, the water pump will not be started until the water switch is detected as closed before the water pump can be restarted;
- This failure can be automatically recovered;
- The wire controller will report failure repair upon water flow failure;

High-voltage Protection

- Detect high-voltage protection switch after the compressor is started for 1 minute. If it is detected that this switch is disconnected for 10 continuous seconds, shutdown protection will be triggered;
- If this failure occurs for 3 times continuously within 30 minutes, the unit will not be recoverable unless powered down (the failure in the first two times can be automatically recovered);
- The wire controller will report failure repair upon failure;

Low-voltage Protection

- Detect low-voltage protection switch after the compressor is started for 5 minutes. If it is detected that this switch is disconnected for 10 continuous seconds, shutdown protection will be triggered;
- If this failure occurs for 3 times continuously within 30 minutes, the unit will not be recoverable unless powered down (the failure in the first two times can be automatically recovered);
- The wire controller will report failure repair upon failure;

Warnings

Excessive Exhaust Protection

- The detection is carried out after the compressor is starts for 1 minute. The overall machine shall be shut down for protection if the discharge temperature is detected as $\geq 125^{\circ}\text{C}$ for 1 continuous minute;
- When the discharge temperature is detected as $\leq 90^{\circ}\text{C}$ this protection will exit;
- If this failure occurs for three times within 30 minutes, the unit will not be recoverable unless powered down (the failure in the first two times can be automatically recovered);
- The wire controller will report failure repair upon failure;

Remark: Three protections, i.e. high-voltage protection, low-voltage protection, and excessive exhaust protection, occur for 3 times accumulatively within 30 minutes. Then the unit is not recoverable unless powered down;

Inlet and Outlet Water Temperature Difference Excessive Protection

- Detect the inlet water temperature and outlet water temperature after the water pump is starts for 1 minute;
- When it is detected that the temperature difference between inlet water temperature and outlet water temperature exceeds 13°C for 10 continuous seconds, shutdown protection will be triggered;
- When inlet and outlet water temperature difference excessive protection occurs, the startup program will be restarted 3 minutes later to detect inlet water temperature and outlet water temperature;
- If this failure occurs for three times within 30 minutes, the unit will not be recoverable unless powered down (the failure in the first two times can be automatically recovered);
- The wire controller will report failure repair upon failure in the third time;

Outlet Water Temperature High Protection

- This protection function is provided under heating mode (including air-conditioning heating mode and hot water mode). This function is not provided under cooling mode;
- Detect after the compressor is started for 5 minutes. When the outlet water temperature is detected as $\geq 70^{\circ}\text{C}$ shutdown protection will be triggered;
- After this protection occurs, when the outlet water temperature is detected as $\leq 55^{\circ}\text{C}$, it will exit from this protection;
- If this failure occurs for three times within 30 minutes, the unit will not be recoverable unless powered down;
- The wire controller will report failure repair upon failure;

Outlet Water Temperature Low Protection

- This protection function is only provided under air-conditioning cooling mode;
- Detect after the compressor is started for 5 minutes. When the outlet water temperature TOUT is detected as $\leq 2^{\circ}\text{C}$, shutdown protection will be triggered;

Warnings

- After occurrence of this protection, when it is detected that TOUT temperature is equal to or greater than $\geq 5^{\circ}\text{C}$ this protection will exit;
- If this failure occurs for 3 times continuously within 30 minutes, it will not be recoverable unless powered down;
- The wire controller will report failure repair upon failure;

Pipe Temperature High Protection

- Under cooling mode, the detection will be carried out after the compressor runs for 5 minutes;
- When the temperature of heating coil is detected as $\geq 70^{\circ}\text{C}$, shutdown protection will be triggered;
- After this protection occurs, when the temperature of TOUT is detected as $\leq 65^{\circ}\text{C}$, it will exit from protection;
- If this failure occurs for three times within 30 minutes, the unit will not be recoverable unless powered down;
- The wire controller will report failure repair upon failure;

Hot Water Tank Temperature High Protection

- Under hot water mode, when the temperature of hot water tank is detected as $\geq 55^{\circ}\text{C}$, the system will enter hot water tank temperature high protection;
- When the temperature of hot water tank is detected as $\leq 53^{\circ}\text{C}$, the system will exit from hot water tank temperature high protection;
- When the system enters hot water tank temperature high protection, the system will conduct the following actions:
 1. Upon air-conditioning demand of the system, the system will enter air-conditioning mode. Otherwise, shutdown protection will be triggered;
 2. If the temperature of hot water tank does not reach the set temperature, the electrical heating of hot water tank will be started;
 3. When this protection occurs, the system can be automatically recovered and no failure will be reported;

Antifreeze Protection

Primary Antifreeze Protection

- Under standby status, when the ambient temperature is $\leq 2^{\circ}\text{C}$ and the inlet water temperature is $\leq 8^{\circ}\text{C}$, the unit will automatically start to run under water pump mode;
- When the ambient temperature is $\geq 4^{\circ}\text{C}$ or the inlet water temperature is $\geq 15^{\circ}\text{C}$, the unit will exit from primary antifreeze protection;
- When this protection occurs, the wire controller will display code but not report repair failure. It can be automatically recovered;

Warnings

Secondary Antifreeze Protection

- Under standby status, when the ambient temperature is $\leq 2^{\circ}\text{C}$ and the inlet water temperature is $\leq 6^{\circ}\text{C}$, the unit will automatically start to run under heating mode;
- When the ambient temperature is $\geq 4^{\circ}\text{C}$ or the inlet water temperature is $\geq 15^{\circ}\text{C}$, the unit will exit from primary antifreeze protection;
- When this protection occurs, the wire controller will display code but not report repair failure. It can be automatically recovered;

Ambient Temperature Low Protection

Under Air-conditioning and Hot Water Mode

- When the ambient temperature is $\leq -20^{\circ}\text{C}$, shutdown protection of the unit is triggered;
- When the ambient temperature is $\geq -17^{\circ}\text{C}$, this protection exits;
- When this protection occurs, repair failure is not reported and failure code is not displayed either.

Inlet Water Temperature Sensor Failure

- Detect after the unit is powered on;
- When short circuit or open circuit of inlet water temperature sensor is detected at any moment, it will be judged as inlet water temperature sensor failure and the system will shut the overall machine down for protection;
- This failure can be automatically recovered;
- The wire controller will report failure repair upon failure;

Outlet Water Temperature Sensor Failure

- Detect after the unit is powered on;
- When short circuit or open circuit of outlet water temperature sensor is detected at any moment, it will be judged as outlet water temperature sensor failure and the system will shut the overall machine down for protection;
- This failure can be automatically recovered;
- The wire controller will report failure repair upon failure;

Temperature Sensor Failure of Heating Coil

- Detect after the unit is powered on;
- When short circuit or open circuit of temperature sensor of heating coil is detected at any moment, it will be judged as temperature sensor failure of heating coil and the system will not shut down;

Warnings

- When this failure occurs, the control of electronic expansion valve under heating mode (including hot water mode) is changed to manual regulation;
- This failure can be automatically recovered;
- The wire controller will report failure repair upon failure;

Temperature Sensor Failure of Cooling Coil

- Detect after the unit is powered on;
- When short circuit or open circuit of temperature sensor of cooling coil is detected at any moment, it will be judged as temperature sensor failure of cooling coil and the system will not shut down;
- When this failure occurs, the control of electronic expansion valve under cooling mode will be changed to manual regulation;
- This failure can be automatically recovered;
- The wire controller will report failure repair upon failure;

Return Air Temperature Sensor Failure

- Detect after the unit is powered on;
- When short circuit or open circuit of return air temperature sensor is detected at any moment, it will be judged as return air temperature sensor failure and the system will not shut down;
- When this failure occurs, the control of electronic expansion valve under cooling/heating (including hot water) mode will be changed to manual regulation;
- This failure can be automatically recovered;
- The wire controller will report failure repair upon failure;

Exhaust Temperature Sensor Failure

- After the unit is powered on, if short circuit of exhaust temperature sensor is detected at any moment, or open circuit of exhaust temperature sensor is detected after the compressor is operated for 1 minute, it will be judged as exhaust temperature sensor failure and the system will not shut down;
- This failure can be automatically recovered;
- The wire controller will report failure repair upon failure;

Warnings

Temperature Sensor Failure of Hot Water Tank

- Detect after the unit is powered on;
- When short circuit or open circuit of temperature sensor of hot water tank is detected at any moment, it will be judged as temperature sensor failure of hot water tank and shutdown protection will be triggered under hot water mode;
- When this failure occurs during high-temperature disinfection, the high-temperature disinfection will exit;
- This failure can be automatically recovered;
- The wire controller will report failure repair upon failure;

Temperature Sensor Failure of Air-conditioning Water Tank

- Detect after the unit is powered on;
- When short circuit or open circuit of temperature sensor of air-conditioning water tank is detected at any moment, it will be judged as temperature sensor failure of air-conditioning water tank and shutdown protection will be triggered under air-conditioning mode (including air-conditioning heating mode and air-conditioning cooling mode);
- This failure can be automatically recovered;
- The wire controller will report failure repair upon failure;

Ambient Temperature Sensor Failure

- Detect after the unit is powered on;
- When short circuit or open circuit of ambient temperature sensor is detected at any moment, it will be judged as ambient temperature sensor failure and the system will not shut down;
- When this failure occurs, the outer draught fan will be forced to run under high-speed wind and relevant antifreeze conditions will be canceled;
- This failure can be automatically recovered;
- The wire controller will report failure repair upon failure;

Communication Failure

- If the wire controller does not receive communication signal of main board all the time within 30 seconds after power-on, the wire controller cannot exit from full-screen display;

Warnings

- If the wire controller fails to receive communication of main board for 2 continuous minutes during operation process, the wire controller will judge communication failure and display failure code;

Test Run and Debugging

Running Check

- Make sure the whole system is already correctly flushed, the valve is already open, and each water tank is already filled up before startup;

Attentions:

During water filling of the system, the air in the water system shall be eliminated through vent valve installed or by opening water outlet at user's terminal equipment so as to complete the whole water filling process.

ding

ump

water

temperature is around 5°C

Air in the System before Startup

- After the system is started, it may require further elimination of air in the water after being heated by the unit.
- If the sound of bubbling is heard from hot pump unit, circulating pump, floor heating pipeline or other heating equipment, the whole system will require further air elimination.
- When the system is in a stable running status (correct pressure; all air is eliminated), the heating control system can run automatically according to user setting.

Preservation and Maintenance

In order to ensure the best service status of the unit, regular maintenance is crucial. Maintenance by using wrong method will lower the equipment performance and shorten the service life of the system.

External Maintenance

1. Check the periphery of heat-pump unit to make sure the air inlet grille is not blocked by tree leaves, snow or other objects;
2. Clean the air inlet grille of the heat exchanger at least once every year; if the environment where the unit is located is relatively dirty, it shall be constantly cleaned to ensure favorable operation of the unit;
3. Make sure there is no much frost and snow covering the heat-pump unit under relatively low temperature;
4. Check if the unit is loose or damaged or if there is damaged part on a regular basis. If such conditions exist and these hidden dangers are not eliminated, the unit may cause personal injury and losses of goods and property;
5. Check if any leakage exists in the water circuit system on a regular basis. Immediately repair it in case of leakage;
6. Check if any leakage exists in the circuit of refrigerant on a regular basis; in case of leakage, refrigerant recycling equipment shall be used to recycle the residual refrigerant in the system. After the circuit is repaired and retested, the refrigerant can be filled into the unit.

Attentions:

After leakage is repaired, the circuit must be retested; the pressure at low-pressure side shall not exceed the maximum working pressure marked in the nameplate.

Refrigerant must be filled to the system under the liquid level. The volume of refrigerant in the steel cylinder shall not be less than 10% of total volume of the cylinder.

- Check if each electrical connection is loose.
- Check if contactor and fuse of key parts are damaged.

Preservation and Maintenance

- Check the insulating status of each power cable.
- Check if the electrical heating and crankcase heater of compressor are damaged.
- Check if the grounding of compressor, fan and water pump is loose.
- Check the winding condition of compressor, fan and water pump.

Machinery maintenance

- Check if the fixed bolts of fan motor, fan blades, compressor and control cabinet are loose.
- Confirm that no water has penetrated to the control cabinet.

Evaporator Coil

Provided the installation environment is relatively dirty or special, it is recommended to clean evaporator fin and coil on a regular basis. Otherwise, the capacity of the unit will be decline.

The methods for cleaning of fin and coil are shown as follow:

- Use banister brush (or use vacuum cleaner to clean the fibers and dust absorbed on the surface of evaporator).
- Use proper detergent to clean.

Attentions:

During cleaning of evaporator, proper force shall be exerted along the direction of fin. Do not clean it horizontally. Otherwise, the fin will be damaged to influence the capacity of the unit.

The evaporator fin is very sharp. Pay attention to protection during cleaning.

Preservation and Maintenance

- Check the water flow by checking the temperature difference of inlet and outlet water;
- Check the concentration of antifreeze protection solution (ethylene glycol or polyethylene glycol);
- Check the status of water quality;
- Check the degree of concentration of water tank and replace it when necessary;
- Check if water leakage exists in the decompression valve of the water system;
- Check if water leakage exists in the air vent valve of the water system;